

# NewPre2300 IoT Edge Controller Hardware Manual

Publication date: November 2022 Document version: V1.0  
Serial number: 112028695

Publisher: Beijing Kyland Technology Co., Ltd.

Address: Building 2, No. 30, Xishan Hui, Shijingshan District, Beijing, 9th Floor.

Website: <http://www.kyland.com.cn>, <http://www.kyland.cn>

Customer Service Hotline: (+8608) 88798888  
Email: [support@kyland.com](mailto:support@kyland.com)

***KYLAND***

## **Preface**

This manual is intended to provide you with hardware installation instructions for the NewPre2300 Edge Universal Controller.

## Legal Notice

Beijing Kyland Technology Co., Ltd. reminds you to carefully read and fully understand the terms of this legal statement before reading or using this document. If you read or use this document, your act of reading or using it will be regarded as approval of the entire contents of this statement. You should obtain this document through the legally authorized channels provided by Beijing Kyland Technology Co., Ltd., and use it only for your own legal and compliant business activities. The content of this document is considered confidential information of Beijing Kyland Science & Technology Co., Ltd. You should strictly observe the obligation of confidentiality. Without the prior written consent of Beijing Kyland Technology Co., Ltd., you are not permitted to disclose the content of this manual to any third party or make it available for the use of any third party.

1. This manual is copyrighted by Beijing Kyland Technology Co., Ltd. Any unit, company, or individual may not, without prior written permission, excerpt, translate, or copy any part or all of the content of this document in any way. It is also prohibited to distribute, advertise, or use it for commercial purposes without permission.
2. Due to product version upgrades, adjustments, or other reasons, the contents of this document may change. Beijing Kyland Technology Co., Ltd. reserves the right to modify the content of this document without any notice or notification. Updated user documents will be periodically published through authorized channels of Beijing Kyland Technology Co., Ltd. You should keep track of the version changes of the user document in real-time and obtain the latest version through authorized channels of Beijing Kyland Technology Co., Ltd.
3. This document is only intended as a reference guide for users using the products and services of Beijing Kyland Technology Co., Ltd. Beijing Kyland Technology Co., Ltd. makes every effort to provide corresponding introductions and operation instructions based on existing technology. However, Beijing Kyland Technology Co., Ltd. explicitly declares that it does not provide any express or implied warranties regarding the accuracy, completeness, applicability, reliability, etc., of the content of this document. Any unit, company, or individual that incurs any errors or economic losses due to the use or reliance on this document, Beijing Kyland Technology Co., Ltd., shall not assume any legal liability. Under no circumstances shall Beijing Kyland Technology Co., Ltd. be liable for any indirect, consequential, punitive, incidental, special, or punitive damages, including profit losses suffered due to the use or reliance on this document (even if Beijing Kyland Technology Co., Ltd. has been informed of the possibility of such damages).
4. If you find any technical errors or typographical errors in this document, please contact Beijing Kyland Technology Co., Ltd. directly. We will make every effort to rectify them in a timely manner.
5. Once again, we declare that infringement will be held accountable.

**Copyright © 2022 Kyland Technology Co., Ltd.**

## Safety Instructions for Use

This product is designed to perform well and reliably within its intended range of use. However, it is necessary to avoid any human-induced damage or destruction of the equipment. Before using the equipment, please read this manual carefully to ensure the safety of both the user and the equipment. After reading this manual, please keep it in a safe place for future reference. Our company is not responsible for any injuries or damages to the equipment caused by a violation of the safety instructions.

- Do not place or install the equipment near a water source or in a humid place. Additionally, ensure that the relative humidity around the equipment remains within the range of 5% to 95% without any condensation.
- Do not place or install the equipment in areas subject to high levels of magnetism, vibration, or heat. Make sure to keep the equipment within the specified operating and storage temperatures.
- Keep equipment securely in place to prevent it from falling. Make sure that the equipment is mounted tightly to prevent any slipping.
- Keep the equipment and its surroundings clean and wipe with a dry soft cotton cloth if necessary.
- Do not place miscellaneous items on the equipment or cables. Keep the equipment's heat dissipation smooth and ensure that the cables are untangled and smooth.
- When operating equipment, it is necessary to wear anti-static gloves or take other safety precautions.
- Avoid exposed metal wires when wiring to prevent metal wires from oxidizing at high temperatures or being electrically connected.
- Equipment must be installed in accordance with national and local electrical regulations.
- Before powering on the equipment, you need to confirm the power supply specifications supported by the device to prevent damage from excessive voltage.
- Keep the power plug and other equipment connectors firmly connected to prevent poor contact affecting the use.
- Please do not plug or unplug the power supply with wet hands. Do not touch the equipment or its accessories with wet hands before turning off the power.
- Before operating electrical equipment, please remove any jewelry (rings, bracelets, watches, necklaces, etc.) or other metal objects to prevent electric shock or burns.
- Do not operate the equipment or connect or disconnect the cables during thunderstorm conditions.

- Please use connectors and cables that are approved by our company's market personnel or technical support staff to avoid any impact on module functionality due to non-compliant connectors and cables.
- Do not dismantle the equipment by yourself. If the equipment malfunctions or is suspected of malfunctioning, please consult our company's marketing personnel or technical support personnel.
- When any equipment parts are lost, please purchase replacement parts under the guidance of our company's marketing personnel or technical support personnel. It is strictly prohibited to select replacement parts on your own.
- The equipment needs to be scrapped in accordance with relevant national regulations to reduce environmental pollution. In the following cases, please disconnect the power supply immediately and contact our company.
- Water entered the device.
- Damage or cracking of the device's casing.
- Abnormal operation or change in device performance.

The device emits an unusual smell, smoke, or abnormal noise.

# Content

<b>1. PRODUCT OVERVIEW</b> .....	6
<b>2. STRUCTURE AND INTERFACES</b> .....	8
2.1 Front Panel.....	8
2.2 Top Panel.....	9
2.3 Bottom Panel.....	10
<b>3. INSTALLATION</b> .....	11
3.1 Dimensional Diagram .....	11
3.2 Installation Methods and Steps .....	12
3.2.2 Antenna Installation and TF Card/SIM Card Installation .....	13
<b>4. WIRING</b> .....	14
4.1 10/100/1000Base-T(X) Ethernet Interface.....	14
4.2 RS232/RS485 Interface.....	15
4.3 USB Interface .....	16
4.4 Video Interface (HDMI Interface).....	18
4.5 CAN Interface.....	19
4.6 DI/DO Interface .....	19
4.7 Console Port.....	21
<b>5 RESET</b> .....	24
<b>6 CPU AUXILIARY UPGRADE BUTTON</b> .....	24
<b>7 LED INDICATOR STATUS</b> .....	25
<b>8. BASIC PERFORMANCE AND SPECIFICATIONS</b> .....	26

## 1. Product Overview

The NewPre2300 IoT Edge Controller utilizes an ARM dual-core Cortex-A72 + quad-core-A53 processor, boasting a maximum frequency of 1.8GHz. It is accompanied by 4GB of DDR4 memory and 32GB of eMMC FLASH storage, delivering an impressive and powerful configuration. Additionally, it features a quad-core ARM Mali-T860 graphic processing GPU, providing ample computing resources for a wide range of industrial field applications. These applications include edge node data acquisition, protocol conversion, real-time control, agile connection, machine vision, intelligent applications, security, and privacy protection.

The NewPre2300 Edge Universal Controller adopts a highly reliable industrial-grade design, with a full- metal integrated fanless body. It operates at a wide temperature range of -20°C to +60°C, making it suitable for indoor installation environments. Additionally, it complies with EMC level 3 and has an IP40 protection rating. The NewPre2300 Edge Universal Controller supports DIN rail installation and various related configurations.

The NewPre2300 Edge Universal Controller can be configured with up to 2 10/100/1000Base-T(X) Ethernet interfaces, 2 RS232 serial interfaces, 2 RS485 serial interfaces, 2 USB interfaces (one USB 2.0 and one USB 3.0), one HDMI interface, one CAN interface, 8 DI interfaces, 8 DO interfaces, one debug serial port (Console port), 4 4G/5G antenna installation ports, 2 WIFI antenna installation ports, one SIM card slot, and one TF card slot.

The specific configuration is as shown in the following table.

Table 1 Configuration Table

Product Model	NewPre2300-R3399-M2D9MW3-0204C01A16DIO
Code Definition	Code Selection
Ethernet Ports	2 x 10/100/1000Base-T(X) Ethernet Ports, RJ45
Serial Interface	2 x RS232
	2 x RS485
	1 x Console
USB Interface	1 x USB3.0、 1 x USB2.0
Video Interface	1 x HDMI
CAN Interface	1 CAN Interface
DI/DO Interface	8 DI Interfaces, 8 DO Interfaces
Antenna Interface	4 x 4G/5G Antenna Mounting Ports, 2 x WIFI Antenna Mounting Ports
Other Interfaces	1 SIM Card Mounting Slot, 1 TF Card Mounting Slot
Operating Temperature	-20°C ~ +60°C
PWR: Power Input	Terminal Interface, 24V Voltage Input



## 2. Structure and Interfaces



Note:

In order to maintain a clean interface and optimize the equipment's operating performance, it is recommended that users consider purchasing a separate dust cover for their interface (optional). The specific type of cover will depend on the equipment's interface.

### 2.1 Front Panel

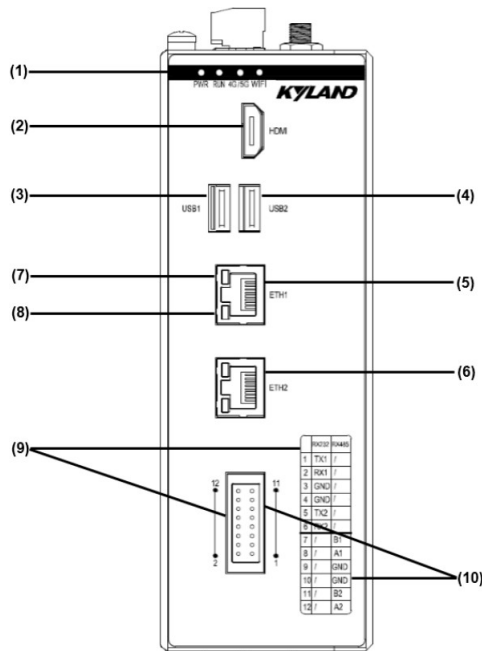

Figure 1 NewPre2300 Front Panel Labeling Diagram

Table 2 NewPre2300 Front Panel Labeling Explanation

Label Number	Identifier	Description
(1)	PWR、RUN、4G/5G、WIFI	LED Indicators PWR: Power Indicator RUN: Operating Indicator 4G/5G: 4G/5G Module In-place Indicator WIFI: WIFI Module In-place Indicator

(2)	HDMI	HDMI Display Interface
(3)	USB1	USB3.0 Communication Interface
(4)	USB2	USB2.0 Communication Interface
(5)	ETH1	10/100/1000Base-T(X) Ethernet Communication Interface 1
(6)	ETH2	10/100/1000Base-T(X) Ethernet Communication Interface 2
(7)	--	10/100/1000Base-T(X) Ethernet Communication Interface Rate Indicator (Yellow)
(8)	--	10/100/1000Base-T(X) Ethernet Communication Interface Connection Status Indicator (Green)
(9)	RS232 ( 1~6 )	2 x RS232 Serial Interface
(10)	RS485 ( 7~12 )	2 x RS485 Serial Interface

## 2.2 Top Panel

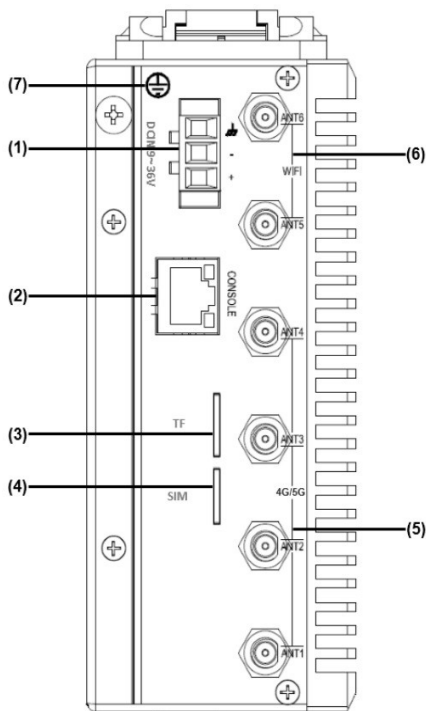



Figure 2 NewPre2300 Top Panel Labeling Diagram

Table 3 NewPre2300 Top Panel Labeling Explanation

Label Number	Identifier	Description
(1)	DCIN 9~36V	Power Interface
(2)	CONSOLE	Debugging Serial Port
(3)	TF	TF Card Installation Slot (Equipped with Rubber Dust Cap)
(4)	SIM	SIM Card Installation Slot (Equipped with Rubber Dust Cap)
(5)	ANT1~ANT4	4G/5G Antenna Mounting Port
(6)	ANT5~ANT6	WIFI Antenna Mounting Port
(7)		Grounding Screw

### 2.3 Bottom Panel

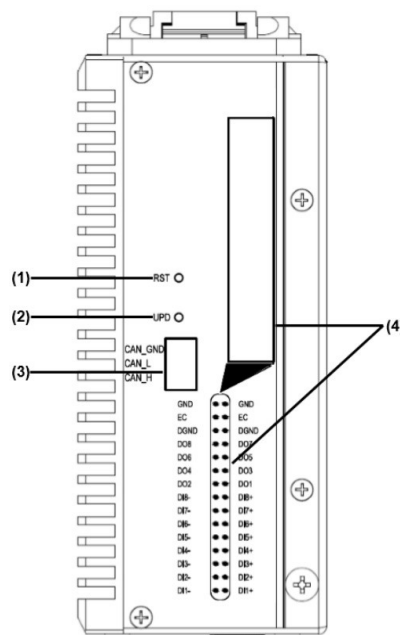

Figure 3 NewPre2300 Bottom Panel Labeling Diagram

Table 4 NewPre2300 Bottom Panel Labeling Explanation

Label Number	Identifier	Description
(1)	RST	Reset: Reset Button
(2)	UPD	CPU: Upgrade Assistance Button
(3)	--	1 x CAN Interface
(4)	--	8 x DI Interfaces + 8 x DO Interfaces

### 3. Installation

#### 3.1 Dimensional Diagram

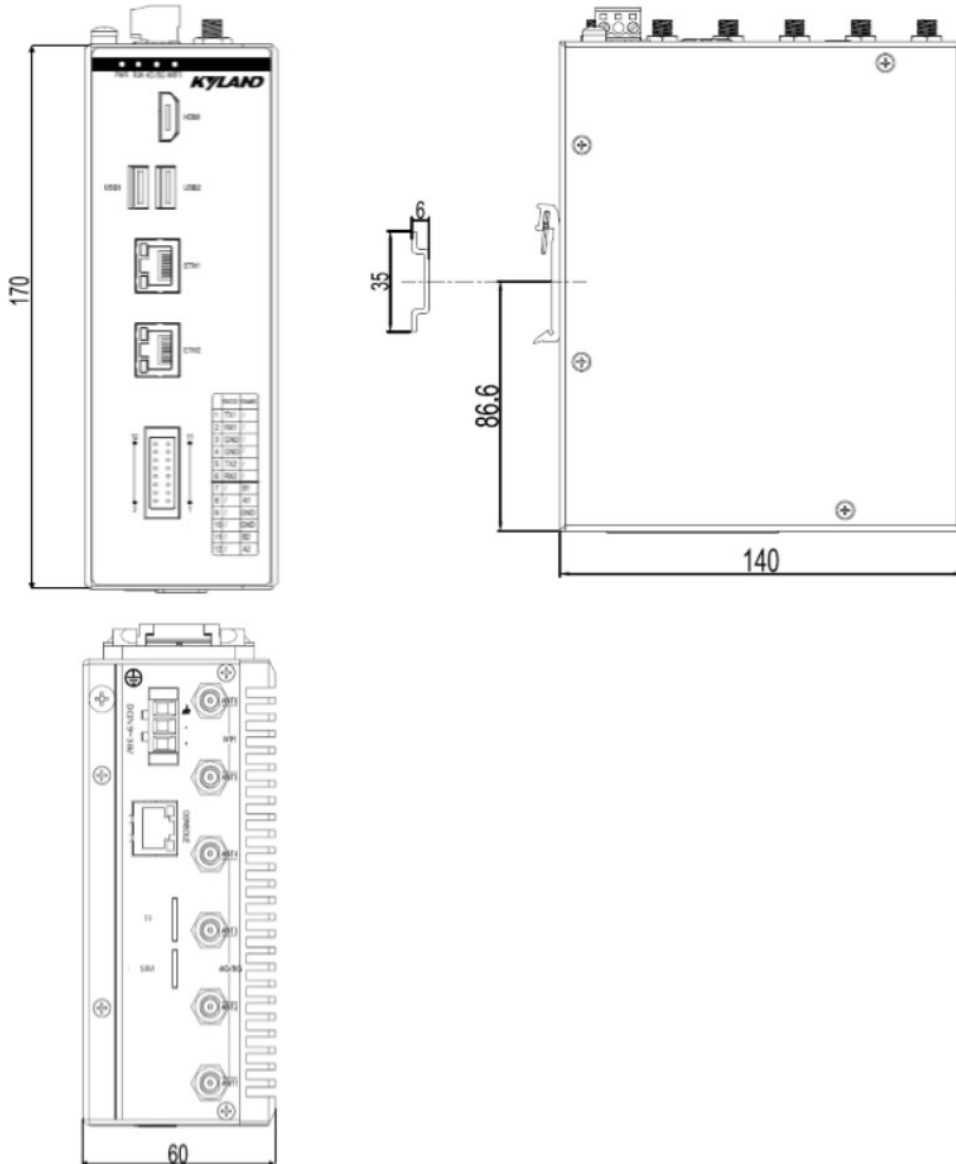

Figure 4 NewPre2300 Installation Dimension Diagram (Units: mm)



**Note:**

The equipment casing is a component of the overall heat dissipation system. It is normal for the casing to heat up during operation, so please refrain from covering it while the equipment is in use.

The images in this manual are for illustrative purposes only. Please refer to the actual product for accuracy.

### 3.2 Installation Methods and Steps

This equipment supports card-rail mounting. Before installing the device, please verify the following installation requirements:

1) Environmental Requirements:

Working temperature: -20°C to

+60°C Storage temperature: -

40°C to +85°C

Relative humidity: 5% to 95% (non-condensing)

- 1 Power requirements: Verify that the operating voltage matches the voltage range identified on the unit.
- 2 Ground resistance requirements: <math><5\Omega</math>.
- 3 Avoid direct sunlight and stay away from heat sources or areas with strong electromagnetic interference.
- 4 The installation environment should meet the requirements of authoritative organizations, and the equipment should not be touched directly by hand to avoid personal injury.
- 5 Only specialized or trained and qualified personnel are permitted to install, replace and repair this equipment.

#### 3.2.1 Din-Rail Mounting

- Card Rail Mounting

Step 1: Select a location for the unit to be installed, ensuring that there is ample space for installation and that heat dissipation is unobstructed.

Step 2: Place the upper portion of the rail mount on the DIN rail, press down on the unit and push the unit in the direction of arrow 1 in the figure below, until the lower portion of the rail mount is also seated on the DIN rail, completing the installation.

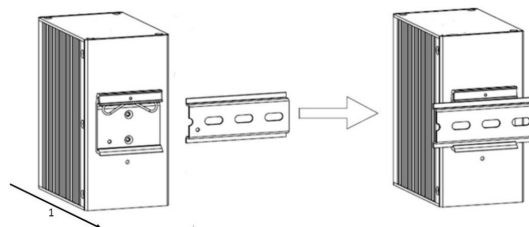
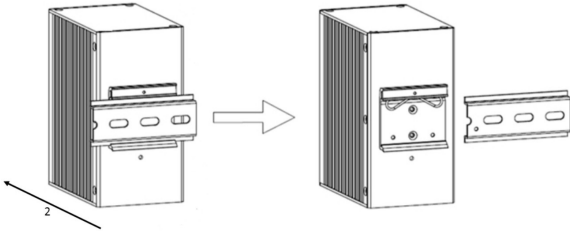

**Figure 5 Card Rail Installation Diagram**

- Card Rail Disassembly

Step 1: Press down on the equipment and push it in the direction indicated by arrow 2 in the figure to detach the lower part of the card rail from the DIN rail.

Step 2: Lift the equipment upward to detach the upper part of the card rail from the DIN rail, completing the disassembly.



**Figure 6 Card Rail Disassembly Diagram**



**Note:**  
Before installing, uninstalling, or moving equipment, please disconnect the power and unplug all cables.

### 3.2.2 Antenna Installation and TF Card/SIM Card Installation

● **Antenna Installation**

Step 1: obtain the corresponding antennas (4G/5G antenna/WIFI antenna).

Step 2: rotate the corresponding antenna clockwise and tighten it onto the corresponding antenna installation port.



**Note:** ANT1-ANT4 are 4G/5G antenna installation ports; ANT5-ANT6 are WIFI antenna installation ports.

● **TF Card/SIM Card Installation**

Step 1: obtain the TF card/SIM card to be installed.

Step 2: remove the rubber dust plug from the TF card/SIM card slot.

Step 3: insert the TF card/SIM card into the TF card/SIM card slot in the correct direction.

Step 4: reinstall the rubber dust plug on the TF card/SIM card slot.



**Attention:**  
Please turn off the power and unplug all cables before installing, disassembling, or moving the equipment.

## 4. Wiring

### 4.1 10/100/1000Base-T(X) Ethernet Interface

The 10/100/1000Base-T(X) Ethernet interface uses a standard RJ45 connector and has adaptive functionality that can automatically configure to 10M/100M/1000M speeds and full- duplex/half-duplex operation modes. It also supports cable MDI/MDI-X auto-detection, which means it can be connected to terminal devices and network devices using either a straight- through cable or a crossover cable.

- **Interface Definition**

RJ45 interface pin numbering is as shown in the diagram below.

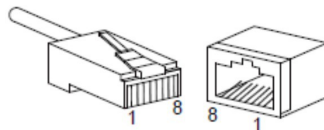



Figure 7 RJ45 Interface Pin Numbering

Table 5 10/100/1000Base-T(X) RJ45 Interface Pin Definition

Pins	MDI-X	MDI
1	Transmit/receive data (TRD1+)	Transmit/receive data (TRD0+)
2	Transmit/receive data (TRD1-)	Transmit/receive data (TRD0-)
3	Transmit/receive data (TRD0+)	Transmit/receive data (TRD1+)
4	Transmit/receive data (TRD3+)	Transmit/receive data (TRD2+)
5	Transmit/receive data (TRD3-)	Transmit/receive data (TRD2-)
6	Transmit/receive data (TRD0-)	Transmit/receive data (TRD1-)
7	Transmit/receive data (TRD2+)	Transmit/receive data (TRD3+)
8	Transmit/receive data (TRD2-)	Transmit/receive data (TRD3-)

 Explanation: "+" "-" represent signal polarity

● Pin Sequence

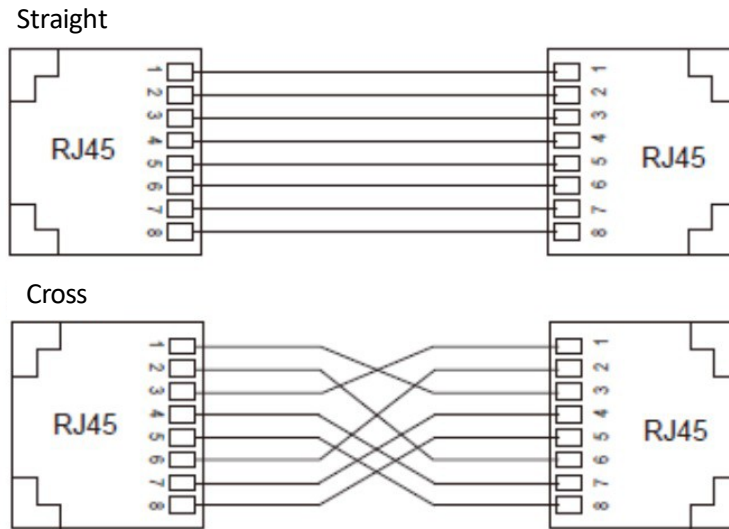

Diagram 8: Direct and crossover cables for connecting 10/100/1000Base-T(X) RJ45 connectors.



Explanation:

RJ45 connector wiring follows the standard 568B (1-orange white, 2-orange, 3-green white, 4-blue, 5-blue white, 6-green, 7-brown white, 8-brown).

**4.2 RS232/RS485 Interface**

The pin definitions for RS232/RS485 interface are shown in the following diagram.

	RX232	RX485
1	TX1	/
2	RX1	/
3	GND	/
4	GND	/
5	TX2	/
6	RX2	/
7	/	B1
8	/	A1
9	/	GND
10	/	GND
11	/	B2
12	/	A2

Figure 9 Interface Pin Definition

Table 6 Serial Interface Pin Definition



Pins	Definition	Description
1	TX1	First RS232 Transmit
2	RX1	First RS232 Receive
3	GND	RS232 Ground (Common for first/second routes)

4	GND	RS232 Ground (Common for first/second routes)
5	TX2	Second RS232 Transmit
6	RX2	Second RS232 Receive
7	B1	First RS485 Bus Output/Input Port, B
8	A1	First RS485 Bus Output/Input Port, A
9	GND	RS485 Ground (Common for first/second routes)
10	GND	RS485 Ground (Common for first/second routes)
11	B2	Second RS485 Bus Output/Input Port, B
12	A2	Second RS485 Bus Output/Input Port, A



Explanation:  
Pins 1-6 are RS232 interface; Pins 7-12 are RS485 interface.

### 4.3 USB Interface

The USB interface is located on the front panel of the equipment and includes 1 USB3.0 interface and 1 USB2.0 interface, both of which use standard Type-A connectors. The pin definitions of the USB interface are shown in the diagram below.

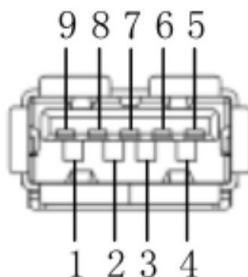

Figure 10 USB3.0 Interface Pin Numbering

Table 7 USB3.0 Interface Pin Definition

<b>USB Pins</b>	<b>Definition</b>	<b>USB Pins</b>	<b>Definition</b>
1	VBUS	2	D-
3	D+	4	GND
5	SSRX-	6	SSRX+
7	GND	8	SSTX-
9	SSTX+		

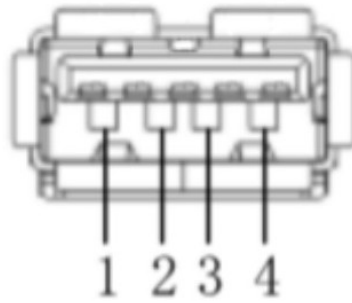

Figure 11 USB2.0 Interface Pin Numbering

Table 8 USB2.0 Interface Pin Definition

USB Pins	Definition	USB Pins	Definition
1	VBUS	2	D-
3	D+	4	GND

#### 4.4 Video Interface (HDMI Interface)

The HDMI interface adopts the standard HDMI connector interface and supports up to 1080P high-definition display. The pin definitions are shown in the accompanying diagram.

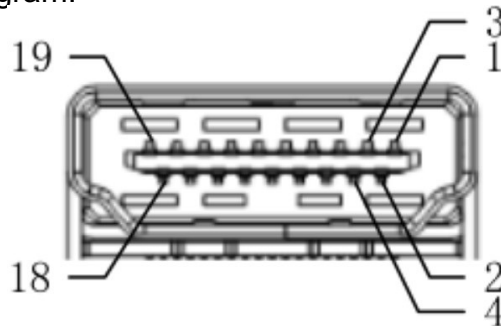

Figure 12 HDMI Interface Pin Numbering

Table 9 HDMI Interface Pin Definition

HDMI Pins	Definition	HDMI Pins	Definition
1	TMDS_Data2+	2	GND
3	TMDS_Data2-	4	TMDS_Data1+
5	GND	6	TMDS_Data1-
7	TMDS_Data0+	8	GND
9	TMDS_Data0-	10	TMDS_Clock+
11	GND	12	TMDS_Clock-
13	NC	14	NC
15	SCL	16	SDA
17	GND	18	+5V
19	Hot plug detect		

### 4.5 CAN Interface

The pin definition for 1 channel CAN Interface are shown in the diagram below.

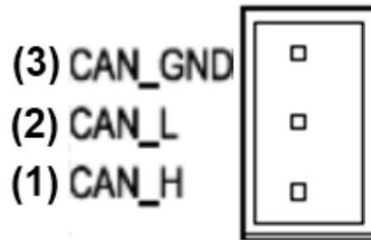

Figure 13 CAN Interface Schematic

Table 10 CAN Pin Definition

Pins	Definition	Description
1	CAN_H	CAN High-Level Voltage Input/Output
2	CAN_L	CAN Low-Level Voltage Input/Output
3	CAN_GND	CAN Ground

### 4.6 DI/DO Interface

The pin definitions for the 8-channel DI+8-channel DO interface are shown in the diagram below.

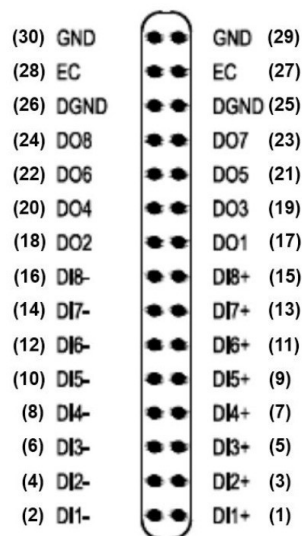

Figure 14 DI/DO Terminal Line Interface Schematic

Table 11 DI/DO Pin Definition

Pins	Definition	Description
1	DI1+	Positive Terminal of the First DI Interface
2	DI1-	Negative Terminal of the First DI Interface
3	DI2+	Positive Terminal of the Second DI Interface
4	DI2-	Negative Terminal of the Second DI Interface
5	DI3+	Positive Terminal of the Third DI Interface
6	DI3-	Negative Terminal of the Third DI Interface
7	DI4+	Positive Terminal of the Fourth DI Interface
8	DI4-	Negative Terminal of the Fourth DI Interface
9	DI5+	Positive Terminal of the Fifth DI Interface
10	DI5-	Negative Terminal of the Fifth DI Interface
11	DI6+	Positive Terminal of the Sixth DI Interface
12	DI6-	Negative Terminal of the Sixth DI Interface
13	DI7+	Positive Terminal of the Seventh DI Interface
14	DI7-	Negative Terminal of the Seventh DI Interface
15	DI8+	Positive Terminal of the Eight DI Interface
16	DI8-	Negative Terminal of the Eight DI Interface
17	DO1	First DO Interface
18	DO2	Second DO Interface
19	DO3	Third DO Interface
20	DO4	Fourth DO Interface
21	DO5	Fifth DO Interface
22	DO6	Sixth DO Interface
23	DO7	Seventh DO Interface
24	DO8	Eight DO Interface
25	DGND	DO Ground
26	DGND	DO Ground
27	EC	Positive Terminal of the External Power Supply for DO
28	EC	Positive Terminal of the External Power Supply for DO
29	GND	Negative Terminal of the External Power Supply for DO
30	GND	Negative Terminal of the External Power Supply for DO



Explanation

- Each DI input voltage range is 5V~30V (with an input resistance of 1K on the board).
- Each DO output current value must not exceed 600mA.
- The external power supply range for DO is 12V~24V.
- Feel free to let me know if there are any further clarifications or adjustments needed.

## 4.7 Console Port

### ● RJ45 Management Port

Use a DB9-RJ45 network management cable to connect the PC's 9-pin serial port with the device's console port. By executing the HyperTerminal software on a WINDOWS system, you can invoke this device's console software to realize the configuration, maintenance, and management functions of the device.

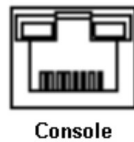

Figure 15 Console Port

### ● DB9-RJ45 Network Management Cable

One end of the DB9-RJ45 network management cable is equipped with a DB9 plug, which must be inserted into the PC's 9-pin serial port. The other end consists of a crimped RJ45 connector that needs to be plugged into the device's console port.

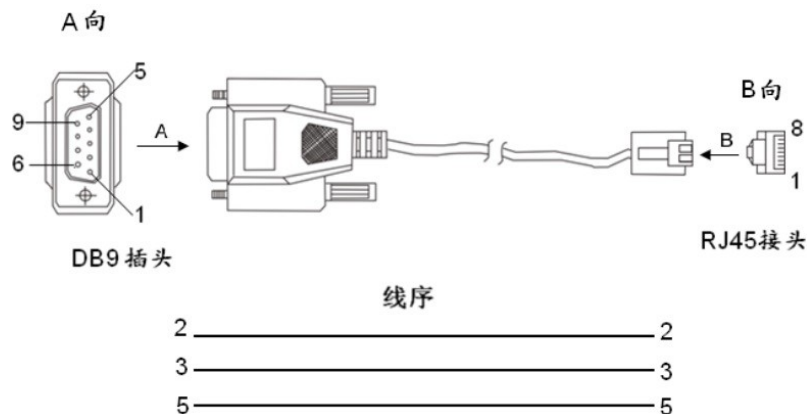

Figure 16 DB9-RJ45 Network Management Cable Wiring

Table 12 Definition of DB9 Interface (9-pin serial port on PC), RJ45 Interface (Console Port)

DB9 Interface (9-pin serial port on PC)		RJ45 Interface (Console Port)	
Pins	Signal	Pins	Signal
2	RXD (Receive Data)	2	TXD (Transmit Data)
3	TXD (Transmit Data)	3	RXD (Receive Data)
5	GND (Ground)	5	GND (Ground)



**Note:**

If your PC does not have a 9-pin serial port or if it is unavailable, you can use a USB to serial cable to connect with the DB9 plug.

Then connect to the PC's USB port for debugging operations. The USB to serial cable must be purchased separately.

## 1. Grounding

Proper grounding of equipment is an important guarantee for equipment's lightning protection and interference prevention. Therefore, users must connect the ground wire correctly.

Additionally, it is necessary to ground the equipment before powering on, and disconnect the ground wire after powering off.

There is a grounding screw on the top panel of the device, referred to as "chassis ground." Crimp one end of the grounding wire to the cold-pressure terminal, secure it to the "chassis ground" using the grounding screw, and then reliably connect the other end to the ground.



**Note:**

The cross-sectional area of the grounding wire should be greater than 2.5mm<sup>2</sup>; the grounding resistance requirement: <5Ω.

## 1. Power Terminals

The power terminals are located on the top panel of the device. Connect the power cables to the device through the power terminals. This device has a single power supply, utilizing a 3-pin 5.08mm pitch plug-in terminal.



**Note:**

The cross-sectional area of the power cables must be greater than 0.75 mm<sup>2</sup> (maximum cross-sectional area 2.5 mm<sup>2</sup>); the grounding resistance requirement: <5Ω.

Copper conductors must be used for onsite wiring, and the temperature must meet 75°C.

3-pin 5.08mm pitch plug-in wiring terminal

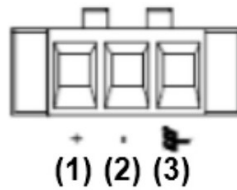



Figure 17 3-pin 5.08mm pitch plug-in terminal (socket)

Table 13 Definitions of 3-pin 5.08mm pitch plug-in terminal.

Terminal Number	Signal Name	Definition
1	+	PWR: +, i.e., the positive end of the power
2	-	PWR: -, i.e., the negative end of the power
3		PGND Protective Ground, i.e., Power Ground

- Wiring and Installation

Step 1: Properly ground the device.

Step 2: Remove the plug from the power terminal on the equipment.

Step 3: Insert one end of the power cord into the power terminal plug according to Table 13 requirements, and securely attach the power cord.

Step 4: Reinsert the plugged power cord into the corresponding power socket on the equipment.

Step 5: Connect the other end of the power cord to the appropriate external power supply system, based on the power requirements stated by the equipment. Check if the power indicator light on the equipment is on. If the light is on, it indicates that the power connection is correct. Wiring and installation should comply with the following specifications.



Table 14 Specifications for Wiring and Installation

Terminal Type	Torque Requirements	Wire Cross-Sectional Area Range (AWG)
Plug-in Terminals	4.5-5.0 lb-in	12-24



**Caution:**  
Before connecting to the power source, please confirm that the power supply meets the marked requirements of the device to avoid damage.



**Warning:**  
Do not touch any exposed wires, terminals, or parts marked with dangerous voltage symbols within the product, to avoid harm.  
Do not disassemble components or plug/unplug connectors during the power-on process.

## 5 Reset

The Reset button is located on the bottom panel of the equipment (RST) and has the function of restarting the equipment. Press and hold the Reset button continuously, then release it to complete the equipment restart operation.

## 6 CPU Auxiliary Upgrade Button

The CPU auxiliary upgrade button is located on the bottom panel of the device (UPD). By holding down the button while powering on the device, you can utilize the CPU's built-in software to perform CPU-related upgrade operations.

## 7 LED Indicator Status

Table 15 LED Indicator Description

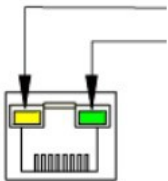
LED	Status	Description
Power indicator light - PWR (green light)	On	Power input connected and running normally.
	Off	Power input not connected or running abnormally.
Running indicator light - RUN (green light)	Flashing	The motherboard CPU is running normally.
	Off	The motherboard's CPU is not booting or operating abnormally.
4G/5G module position indicator light - 4G/5G (green)	On	4G/5G Module in place
	Off	4G/5G Module not in place
WIFI module in-place indicator light - WIFI (green)	On	WIFI Module in place
	Off	WIFI Module not in place
 <p>Blinking/Yellow Connection Status/Green</p>		
10/100/1000Base-T(X) Ethernet Interface Speed Indicator Light (Yellow)	On	1000M Working State (i.e., 1000Base-TX)
	Off	10/100M Working State (i.e., 10/100Base-T(X)) or no connection
10/100/1000Base-T(X) Ethernet Interface Connection Status Indicator Light (Green)	On	Port has established a valid network connection
	Flashing	Port has network activity
	Off	Port does not have a valid network connection established

## 8. Basic Performance and Specifications

Power		
Power Identification	Input rated voltage range	Maximum input voltage range
L3	24VDC	9-36VDC
Terminal Connection	3-pin 5.08mm pitch plug-in wiring terminal	
Rated Power	<12W	
Mechanical Structure		
Chassis	All-metal integrated body	
Cooling Method	Natural cooling, fanless	
Protection Level	IP40	
Installation Method	Rail-mounting (butterfly rail)	
Dimensions (W×H×D)	140mm×170mm×60mm (Does not include protruding parts of connectors and dimensions of card track components)	
Weight	<2KG	
Environment		
Operating Temperature	-20°C ~ +60°C	
Storage Temperature	-40°C ~ +85°C	
Relative Humidity	5% ~ 95%, non-condensing	
Warranty Period		
Warranty Period	2 years	