

KYLAND

Hyperie 8300

Next Generation Power Server

Make substation more RealTime, more Powerful,
more Reliable and more Cost Effective



» Introduction

Kyland's Hyperie 8300 is a power automation platform, equipped with various data interfaces, built-in hundreds of protocols, integrated soft-PLC control functions and SCADA/HMI functionality, pre-installed Intewell Hypervisor for real-time virtualization, open platform for customized APPs, making it an ideal solution for automation system of transmission/distribution substation, distributed PV power generation, wind power, thermal energy storage, etc.

Data Collection and Concentration

- Multi-kinds of interfaces for extension connectivity: Ethernet copper and fiber port, serial port, DI/DO, IRIG-B, HDMI, VGA, USB
- Multi-protocol IEDs data acquisition, processing, storage; multi-protocol conversion, data forwarding and breakpoint continuation transfer
- Built-in hundreds of protocols for communication with various substation devices, compliant with the majority protocols within substation automation, such as IEC61850 Server/Client, IEC60870-5-101/103/104, DNP3.0, Modbus TCP/RTU, SEL faster, ABB Spabus, Alstom Courier, etc.

Control Platform

- Integrates Drag-and-drop graphical programming development suite
- Compliance with IEC61131 programming standard and support the IEC61131-3 programming language of ST, FDB, LD
- Support C++, MatLab/Simulink programming
- Support SNMP v1/v2/v3

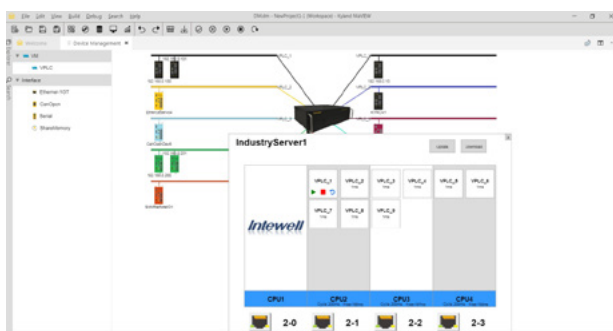
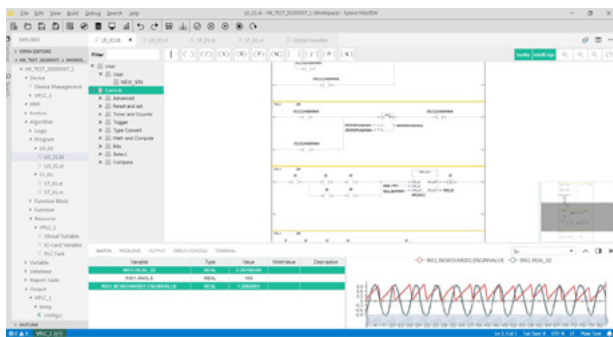

Powerful SCADA/HMI Functionality

- Collect the operation status, communication status, operating parameters, failure report and other information of system devices
- Monitoring the operation status and fixed value data of the primary and secondary system, protection device and fault recorder in a friendly and visually way
- Support professional and practical HMI development tool and provide comprehensive and professional graphics, reports, curves/charts, statistical analysis and event alarm/recording for power applications
- Alarm information management and alarm classification assist operator in alarm event location
- User permission management functions, capable of setting user groups and access right by region, restricting the operation of protection devices in operators, restricting the access right of system devices etc.

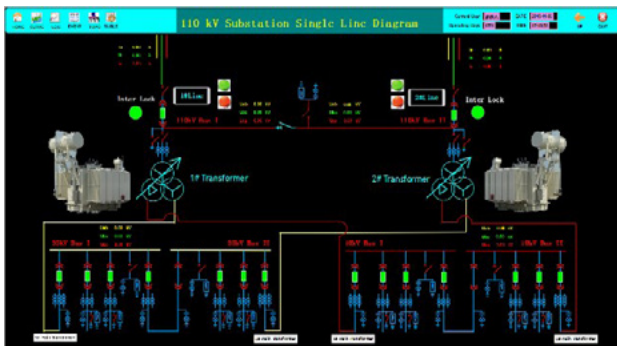

Pre-install Intewell Hypervisor with real-time virtualization

- Quad Core Intel i7 processor platform provides powerful and flexible computing ability to support real-time applications
- Virtualize up to 20 software-defined RTOS on a single CPU platform, allowing simultaneous operation of real time OS and Non-real time OS with isolation
- Support the event response time of 2μs and the minimum cycle time of 50μs to achieve high-real time control
- Install Windows/Linux on virtualized core, compatible with Windows and Linux-based APPs

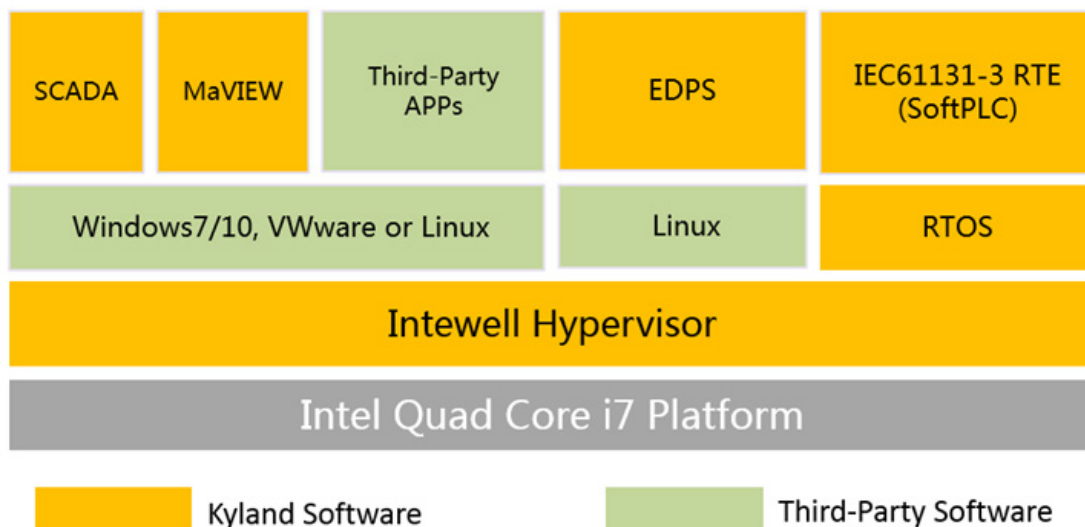

System Architecture

Industry Grade Design for Harsh Environment

- Fanless design and -40°C to +75°C operating temperature for harsh environments
- Compliant with IEC61850-3 and IEEE 1613 for power automation system
- Wide power input range: 85VAC ~ 264VAC / 100VDC ~ 360VDC, redundant power supplies

» Technical Specification

Processor, Memory and Storage

CPU	Intel® Core™ i7-8665UE Quad Core
RAM	16GB/32GB DDR4 SODIMM
Storage Slot	2.5" SSD slots x 2

Interface

Ethernet Ports	6 x 10/100/1000Base-T(X) RJ45 ports 2 x Gigabit SFP slots for fiber SFP module
Serial Ports	8 x RS232/RS485 ports, DB9/terminal connector, 2.5KV isolation and 2KV surge protection
DIDO	4 x DI, 4 x DO
IRIG-B	1 x IRIG-B IN, 1 x IRIG-B OUT
Console	RS232, DB9
Alarm Contact	2 x programmable normally close (NC) dry contact outputs for system failure alarm, 5A@250VAC 5A@30VDC 2 x power loss alarm contacts, 5A@250VAC 5A@30VDC
USB	2 x USB2.0 (front), 3 x USB3.0 (rear)
Display	1 x VGA, 2 x HDMI

Expansion Slot

2 expansion slots for optional Ethernet RJ45/
fiber port, DIDO and serial port modules

LED

System	Run: RUN Power: PWR1, PWR2 Alarm: ALM1, ALM2
Programmable LED	1-8
LAN	2 per RJ45/SFP port (LINK, ACT)
Serial	2 per port (TXD, RXD)
DIDO	1 per port

Power Supply

Input Range	85VAC~264VAC/100VDC~360VDC redundant power supplies
Power Button	ON/OFF

Power Loss Alarm	Support
Power Consumption	Max 50W

Physical Characteristics

Housing	Metal, fanless
Dimension	483mm x 133mm x 330mm
Weight	9kg
Mounting	19 inch Rack mounting

Environmental Limits

Operating temperature	-40°C to +75°C
Storage temperature	-40°C to +85°C
Ambient Relative Humidity	5% to 95% (non-condensing)

Protocol

Server	IEC 61850-8-1 Server (MMS/GOOSE) IEC 60870-5-101 IEC 60870-5-103 IEC 60870-5-104, Single or redundant, DNP 3.0 Serial and LAN/WAN Modbus RTU and TCP/IP Multi-Vender Meter protocol CDT
--------	--

Client	IEC 61850-8-1 Client (MMS/GOOSE) Courier SEL Fast Meter IEC 60870-5-101 IEC 60870-5-103 IEC 60870-5-104, Single or redundant DNP 3.0 Serial and LAN/WAN Modbus RTU and TCP/IP Multi-Vender Meter protocol CDT
--------	--

Standards

IEC61850-3 and IEEE1613

Warranty

5 years

» Substation Automation Network

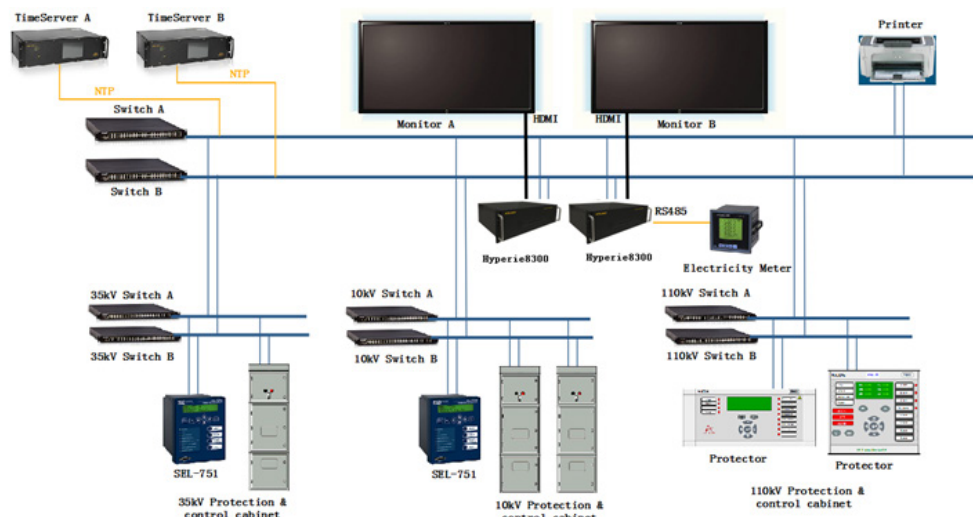

Front and Rear View

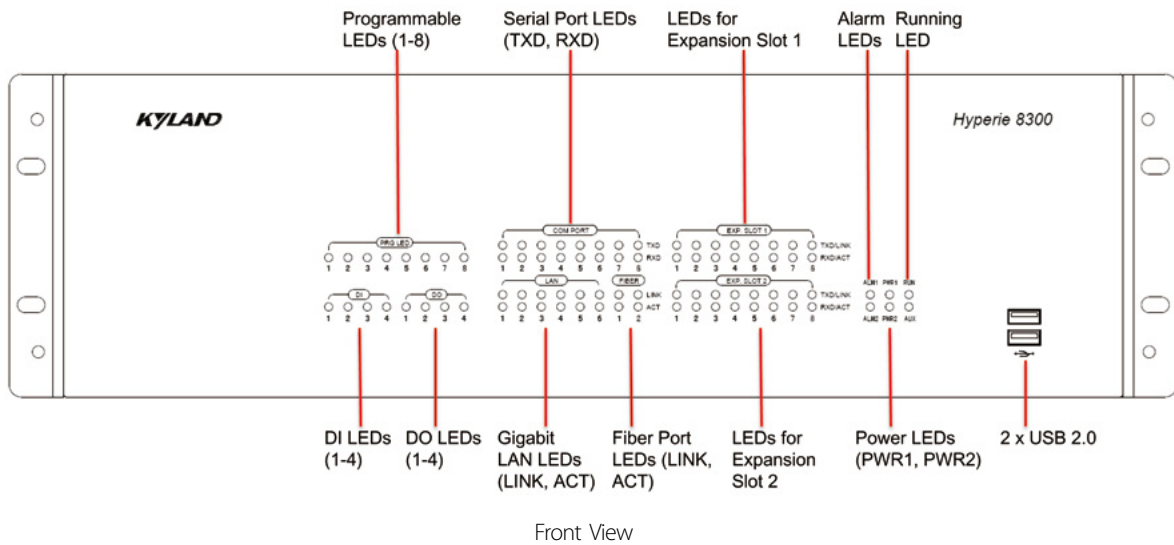

Front View

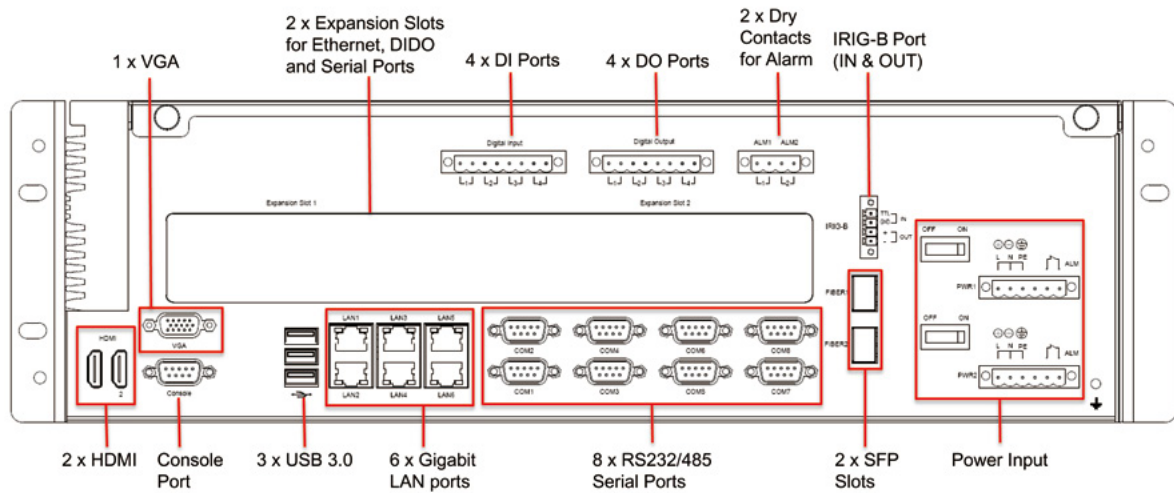

Rear View

Ordering Information

Model Name	Description
Hyperie8300	CPU Intel i7-8665UE 1.7GHz, 8MB cache, Quad Core, includes: 6 x 10/100/1000Base-T(X) RJ45 ports, 8 x RS232/RS485 ports, 4DI and 4DO, 2 x Gigabit SFP slots, 2 x programmable normally close (NC) dry contact outputs, 5 x USB, 2 x HMI, 1 x VGA, 85VAC~264VAC / 100VDC~360VDC, redundant power supplies, -40°C to +75°C operating temp.

Expansion Module (Support up to 2 Modules)

Model Name	Description
HYM-8D-232/485	Serial port module with 8 x RS232/485 serial ports, terminal connectors
HYM-8DI8DO	DI/DO module with 8 x DI and 8 x DO
HYM-2GX	Ethernet port module with 2 x 1000Base-X SFP slots
HYM-6GE	Ethernet port module with 6 x 10/100/1000Base-T(X) RJ45 ports

Selectable Features

Model Name	Description
16GB DDR4	16GB DDR4 SODIMM
32GB DDR4	32GB DDR4 SODIMM
256GB SSD	256GB MLC SSD
512GB SSD	512GB MLC SSD
1TB SSD	1TB MLC SSD
Operating System	WINDOWS 10
	Linux